

EXPRESS ORDER FORM

XL5 PEDIATRIC MANUAL WHEELCHAIR

For Alberta Aids to Daily Living only

**AADL MSRP
PRICES ONLY**

AADL #W116
Effective October 1, 2018



Date: _____ P.O.#: _____ Account#: _____

Made for (client): _____

Ordered by: _____

Organization: _____

Address: _____

Phone: _____ Fax: _____

Select store location - AADL Numbers

Calgary - AADL 00000 78000 003 Edmonton - AADL 00000 78000 001 Grande Prairie - AADL 0000 665538 001

STANDARD SEAT-TO-FLOOR WILL BE SET AT 15 ½" BASED ON 20" OR 22" SPOKE WHEELS AND 6" CASTERS.

NOTE: ITEMS WITH THIS SYMBOL (▲) ARE NOT FUNDED BY AADL

XL5 PEDIATRIC MANUAL WHEELCHAIR	<input type="checkbox"/>	\$2 395
FRAME COLOR		
Glossy Black <input type="checkbox"/> Candy Blue <input type="checkbox"/>	←	N/C
SEAT WIDTH		
11" <input type="checkbox"/> 12" <input type="checkbox"/> 14" <input type="checkbox"/> 16" <input type="checkbox"/>	←	N/C
SEAT DEPTH		
12" <input type="checkbox"/> 14" <input type="checkbox"/> 16" <input type="checkbox"/>	←	N/C
BACK HEIGHT (STRAIGHT CANE)		
16" <input type="checkbox"/>	←	STD
BACK POST		
Straight with Push Handle 0° <input type="checkbox"/>		STD
SEAT		
Standard Seat Sling <input type="checkbox"/>		STD
2" Seat Cushion <input type="checkbox"/>		N/C
BACK		
Standard Upholstery <input type="checkbox"/>		STD
ANGLE ADJUSTABLE BACKREST		
Back Angle -5° <input type="checkbox"/> 0° <input type="checkbox"/> 5° <input type="checkbox"/> 10° <input type="checkbox"/> 15° <input type="checkbox"/>	←	N/C
ANGLE ADJUSTABLE STROLLER BAR		
Angle Adjustable Stroller Bar (#13-00016) <input type="checkbox"/>		N/C
ARMREST		
« T » Type - Removable, Height Adjustable <input type="checkbox"/>		N/C
ARMPAD		
Full Length (#ST-02525) <input type="checkbox"/>		N/C
FOOTREST (ADJUSTABLE IN HEIGHT FROM 6" to 9")		
90° Swing Away - Desired Height : _____ " <input type="checkbox"/>		STD
70° Swing Away - Desired Height : _____ " <input type="checkbox"/>		STD

STANDARD FEATURES	
Color: Glossy Black/Candy Blue	Wheel Locks: Push to Lock
Weight Capacity: 250 lb	Axles: Threaded Axles
Frame: Standard and Hemi	Armrest: « T » Type
Seat Width: 11", 12", 14", 16"	Footrest: 70° and 90° Swing Away
Seat Depth: 12", 14", 16"	Handrim: Aluminium
Seat-to-Floor Height: 13" to 20 ½"	Transport Tie-Downs
Back Height: 16"	Anti Tip
Rear Wheels: 20", 22"	2" Seat Cushion
Urethane Front Wheel: 5", 6", 8"	

FOLDING FOOTPLATE	
Angle and Depth Adjustable (Width 4" x Depth 5") <input type="checkbox"/>	\$180 Pair
Angle and Depth Adjustable (Width 6" x Depth 6 ¾") <input type="checkbox"/>	\$180 Pair
Adjustable Length Heel Loops <input type="checkbox"/>	\$55 Pair
WHEEL LOCKS	
Push to Lock <input type="checkbox"/>	STD
Fixed Extension Handle <input type="checkbox"/>	\$40 Pair ▲
Telescopic Extension Handle <input type="checkbox"/>	\$60 Pair
AXLES TYPE	
Threaded Axles <input type="checkbox"/>	STD
Quick Release Axle <input type="checkbox"/>	\$105
REAR WHEELS	
20" <input type="checkbox"/> 22" <input type="checkbox"/>	← STD
ANTI TIP	
Anti Tip <input type="checkbox"/>	STD
HANDRIM	
Aluminium <input type="checkbox"/>	STD
Plastic Coated Handrim <input type="checkbox"/>	\$130 Pair ▲
POSITIONING STRAP	
Center-Pull Auto Style Hip Belt <input type="checkbox"/>	\$75 ▲
SPOKE GUARDS	
PR-000 Transparent Spoke Guards <input type="checkbox"/>	N/C

AADL EXCLUSION LIST

PEDIATRIC XL5 - NOT FUNDED OPTION LIST

- Fixed Extension Handle
- Plastic Coated Handrim
- Center-Pull Auto Style Hip Belt

Select store location - AADL Numbers

Calgary - AADL 00000 78000 003 Edmonton - AADL 00000 78000 001 Grande Prairie - AADL 0000 665538 001

FRONT SEAT TO FLOOR HEIGHT

SELECT DESIRED HEIGHT

XL5

Hemi Frame — Short Fork

POSITION	FRONT WHEEL DIAMETER		
	5"	6"	8"
A			
B	13 <input type="checkbox"/>	13 ½ <input type="checkbox"/>	
C	13 ½ <input type="checkbox"/>	14 <input type="checkbox"/>	
D	14 <input type="checkbox"/>	14 ½ <input type="checkbox"/>	15 ½ <input type="checkbox"/>

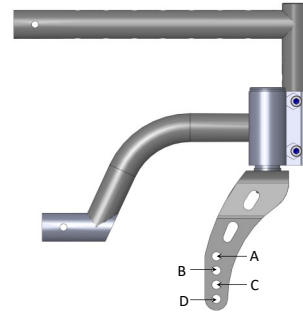

Standard Frame — Short Fork

POSITION	FRONT WHEEL DIAMETER		
	5"	6"	8"
A	15 ½ <input type="checkbox"/>		
B	16 <input type="checkbox"/>	16 ½ <input type="checkbox"/>	
C	16 ½ <input type="checkbox"/>	17 <input type="checkbox"/>	
D	17 <input type="checkbox"/>	17 ½ <input type="checkbox"/>	18 ½ <input type="checkbox"/>

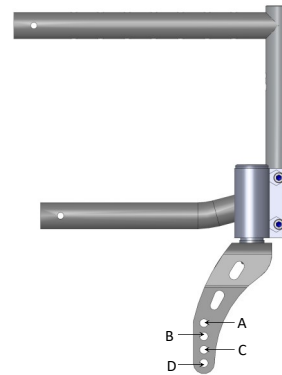

Standard Frame — Long Fork

POSITION	FRONT WHEEL DIAMETER		
	5"	6"	8"
A	18 <input type="checkbox"/>	18 ½ <input type="checkbox"/>	19 ½ <input type="checkbox"/>
B	18 ½ <input type="checkbox"/>	19 <input type="checkbox"/>	20 <input type="checkbox"/>
C	19 <input type="checkbox"/>	19 ½ <input type="checkbox"/>	20 ½ <input type="checkbox"/>
D	19 ½ <input type="checkbox"/>	20 <input type="checkbox"/>	21 <input type="checkbox"/>

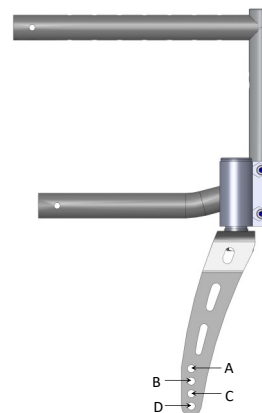

Select store location - AADL Numbers
 Calgary - AADL 00000 78000 003 Edmonton - AADL 00000 78000 001 Grande Prairie - AADL 0000 665538 001

REAR FLOOR TO SEAT HEIGHT TABLE

REAR WHEEL DIAMETER XL5 <i>select desired height</i>		
POSITION	20"	22"
A	13 <input type="checkbox"/>	14 <input type="checkbox"/>
B	13 ½ <input type="checkbox"/>	14 ½ <input type="checkbox"/>
C	14 <input type="checkbox"/>	15 <input type="checkbox"/>
D	14 ½ <input type="checkbox"/>	15 ½ <input type="checkbox"/>
E	15 <input type="checkbox"/>	16 <input type="checkbox"/>
F	15 ½ <input type="checkbox"/>	16 ½ <input type="checkbox"/>
G	16 <input type="checkbox"/>	17 <input type="checkbox"/>
H	16 ½ <input type="checkbox"/>	17 ½ <input type="checkbox"/>
I	17 <input type="checkbox"/>	18 <input type="checkbox"/>
J	17 ½ <input type="checkbox"/>	18 ½ <input type="checkbox"/>

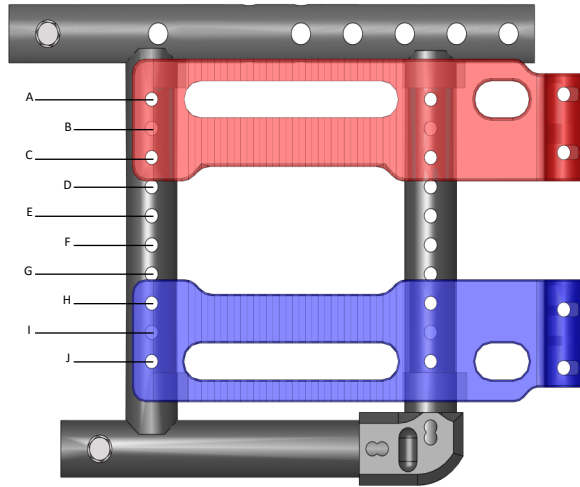

Note - The measures are for reference purposes only. They depend on the wheel diameter, tilt angle and the rear wheel axle location.

REFERENCE SCHEME

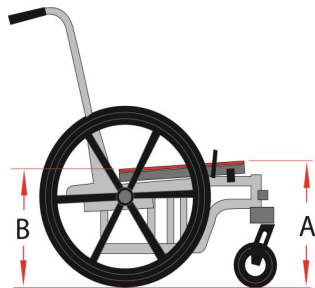

A: SEAT-TO-FLOOR HEIGHT : _____

B: REAR SEAT-TO-FLOOR HEIGHT: _____

REAR WHEEL POSITION

Choose the rear wheel desired position

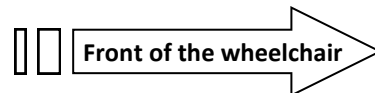
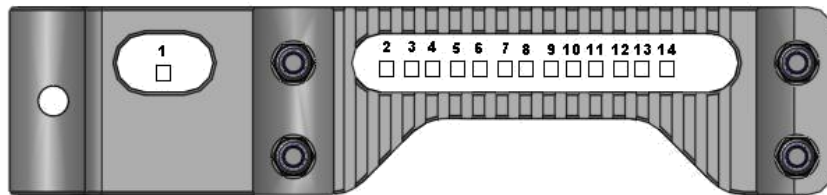

NOTES

AADL EXCLUSION LIST

PEDIATRIC XL5 - NOT FUNDED OPTION LIST

- Fixed Extension Handle
- Plastic Coated Handrim
- Center-Pull Auto Style Hip Belt